

CUSTOM MADE LAMINATED SHUNTS

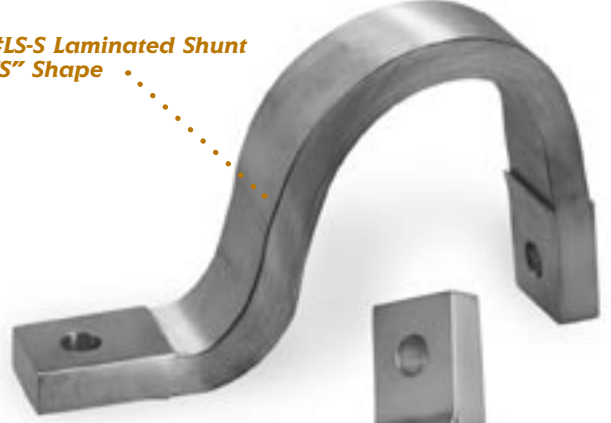

*#LS-S Laminated Shunt
"S" Shape*



*#LS-J Laminated Shunt
"J" Shape*



*#LS-L Laminated Shunt
"L" Shape*

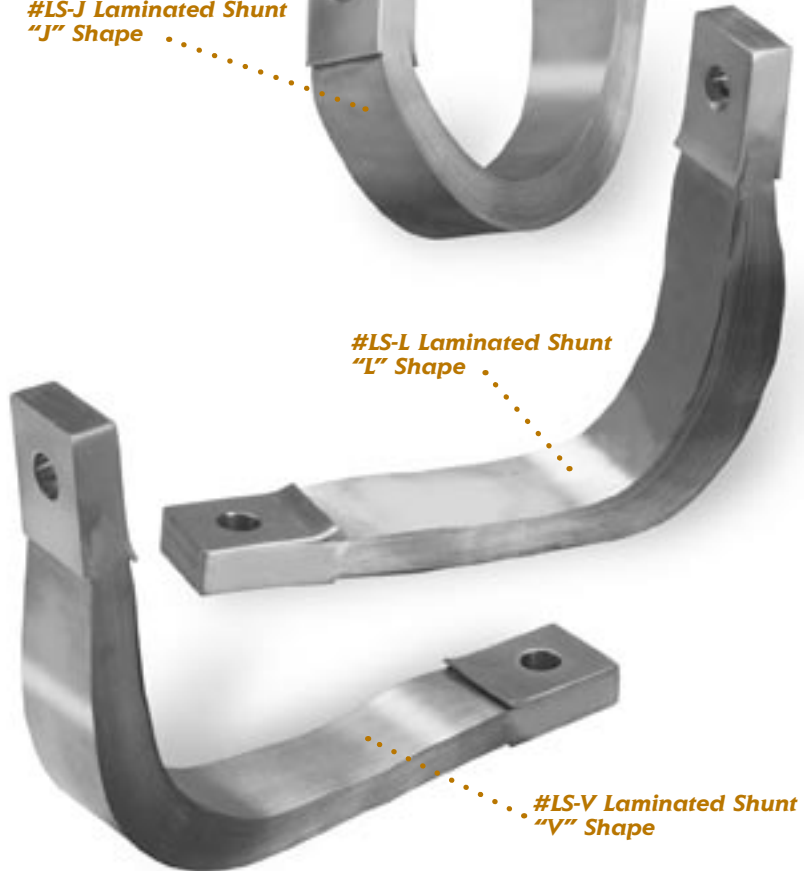

*#LS-C Laminated Shunt
"C" Shape*



*#LS-V Laminated Shunt
"V" Shape*

Watteredge also manufactures riveted custom shunts for those less demanding applications.

Unique Press Weld[™] Method

The Unique Press Weld[™] manufacturing process for secondary connectors is available from Watteredge. This process revolutionized the manufacture of laminated shunts, replacing previous methods of soldering and clipped. Press Weld shunts and connectors give you cost effective operation through:

- Lower resistance values equal to flat copper bar
- Minimal voltage loss
- Balanced flow of electrical current

Watteredge manufactures a broad variety of custom made shunts for each particular type of welding equipment. Strip copper is stocked in various sizes to meet most shunt design requirements. Refer to the laminated shunt selection form or consult your Watteredge sales representative for ordering assistance.

Technical Specifications

Selection Form

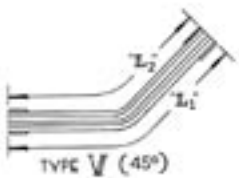
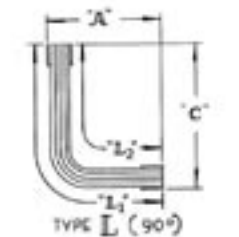
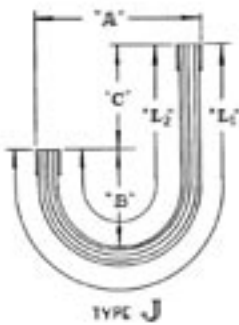
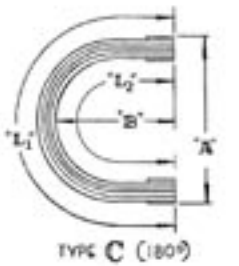
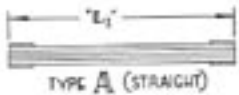

Press Weld Type (circle one) or Riveted Type (circle one)
 'A' 'C' 'J' 'L' 'V' 'A' 'C' 'J' 'L' 'V'
 (Refer to the types at left and supply the dimensions indicated where they apply.)

Thickness of Stack _____ Shunt Width _____ A _____ B _____ C _____

Length: (outside) L₁ _____ (inside) L₂ _____

Material Thickness (circle one):

.003 .005 .010

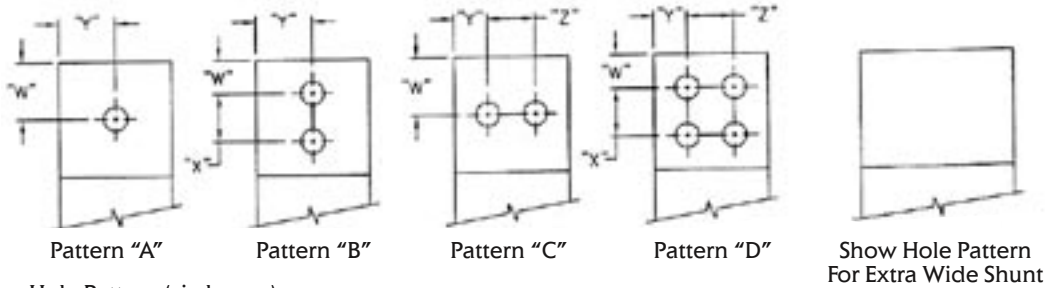

Hole Pattern (circle one)

A B C D Other

Dimension (specify in inches as applicable)

'W' _____ 'X' _____ 'Y' _____ 'Z' _____

Hole Diameter (please specify in inches) _____

End Clip (.062 thick standard) (indicate style w/ dimensions):

Dimension: No Flare _____ Flare _____



Cover Option (circle one): Teflon Fiberglass

Plating Option (circle one): Silver Tin Other _____

Quantity _____

Company Name _____

Address _____

City _____ State _____ Country _____ Zip _____

Phone _____ Fax _____

Buyer's Name _____ Email _____

**ISO 9001:2000
REGISTERED**